



FUHR

DER PROGRAMM-ÜBERBLICK
PROGRAMME OVERVIEW

www.fuhr.de



SICHERHEIT, DIE ÜBERZEUGT COMPELLING SECURITY

FUHR ist einer der führenden Hersteller von Mehrfach-Verriegelungssystemen für jede Anforderung und jede Türkonstruktion. Im Privat- oder im Objektbereich, von der Nebeneingangstür bis zur komplexen Fluchttürkonstruktion. Ganz gleich, ob Standard-, Automatik-, oder vollmotorisches Schloss – mit den FUHR Komplett-Programmen finden Sie eine Lösung für jede Anwendung.

In dieser Broschüre erhalten Sie einen schnellen Überblick über das volle Programm der FUHR Verriegelungs- und Zutrittskontrollsysteme und vielfältige Lösungsmöglichkeiten. Für weitere Informationen scannen Sie einfach den jeweiligen QR-Code.

FUHR is a leading manufacturer of multipoint locking systems. For every need and every type of door. For personal or business use. From side/back doors to sophisticated emergency exit door systems. Whether you need a standard, automatic or fully motorised lock, you'll find a solution for every application in FUHR's comprehensive product ranges.

This brochure provides a quick overview of the complete range of FUHR locking and access control systems and versatile solution options. Simply scan the QR code for further information.



FUHR

www.fuhr.de

INHALTSVERZEICHNIS

TABLE OF CONTENTS

SYSTEMLÖSUNGEN 08-23 SYSTEM SOLUTIONS

Aluminium-/Stahltüren 10-11

Aluminium/Steel doors

Holztüren 12-13

Timber doors

Kunststofftüren 14-15

uPVC doors

Kunststofftüren/Kompaktprogramm 16-17

uPVC doors/compact range

Funktionstüren 18-19

Functional doors

Wohnungsabschlusstüren 20-21

Apartment entrance doors

Ersatz & Nachrüstung 22-23

Replacement & retrofitting



SYSTEM-ERGÄNZUNGEN 24-33
SYSTEM ADDITIONS

Zutrittslösungen 26-29
Access solutions

Elektro-Türöffner 30-31
Electric strikes

Zubehör 32-33
Accessories

PROGRAMM-ERGÄNZUNGEN 34-37
PRODUCT RANGE ADDITIONS

Fenstersicherung 36-37
Window locking device

Metallbau & Riegel 36-37
Metal construction & bolts

VORSCHAU 38-39
PREVIEW

8 VERRIEGELUNGSARTEN – UNZÄHLIGE LÖSUNGEN

8 LOCKING TYPES – COUNTLESS SOLUTIONS



Typ 1
Röllzapfen

Type 1
Roller cams



Typ 2
Pilzkopfzapfen

Type 2
Mushroom cams



Typ 3
Schwenkriegel

Type 3
Hook bolts



Typ 4
Automatik-Fallenriegel

Type 4
Automatic
deadlocking latches

Die große Produktvielfalt unserer Komplett-Programme umfasst Schlösser und Verriegelungsarten für alle Türmaterialien und ermöglicht die Abstimmung auf individuelle Sicherheitsansprüche jeder Tür. Dank der ständig wirksamen Mehrfach-Verriegelung wird einem Türverzug permanent vorgebeugt und so für dauerhafte Dichtigkeit gesorgt.

The wide variety of products in our comprehensive product ranges includes locks and locking types for all door materials, allowing you to match them to the individual security requirements of each door. The permanently effective multipoint locking system constantly keeps the door from warping, ensuring a lasting seal.



Typ 8
Bolzenriegel

Type 8
Round bolts



Typ 9
Duo-Bolzenriegel

Type 9
Dual round bolts



Typ 10
Automatik-Fallen-
bolzen-Schwenkriegel

Type 10
Automatic latching
and hook bolts



Typ 11
Schwenkriegel
mit Duo-Bolzenriegel

Type 11
Hook bolts with dual
round bolts



Anwendungsvielfalt neu definiert.
Application variety redefined.

SYSTEMLÖSUNGEN

SYSTEM SOLUTIONS

Mit unseren Systemlösungen haben wir Komplett-Programme zusammengestellt, die ideal auf die unterschiedlichen Türmaterialien und Bedürfnisse zugeschnitten sind. Die Programme garantieren Ihnen eine effiziente Verarbeitung und eine anwendungsorientierte Flexibilität. Und sie geben Ihnen die Gewissheit, dass alle Komponenten optimal aufeinander abgestimmt sind. Ergänzt werden die Programme um profilspezifische Schließleisten, Schließteile, Standflügelbeschläge sowie umfangreiches Zubehör.

We have put together comprehensive product ranges with our system solutions that are perfectly tailored to different needs and door materials. The product ranges guarantee you efficient installation and application-oriented flexibility. And they provide certainty that all the components are optimally tailored to one another. Our ranges also include profile-specific one-piece strike plates, individual strike plates, inactive leaf locking systems and various accessories.

SYSTEMLÖSUNG SYSTEM SOLUTION

ALUMINIUM-/STAHLTÜREN ALUMINIUM/STEEL DOORS



Rationell
Streamlined



Flexibel
Flexible



Effizient
Efficient



Variabel
Variable



Nachhaltig
Sustainable



Praktisch
Practical

Prospekt (DE) 

Brochure (EN) 

Website (DE) 

Website (EN) 

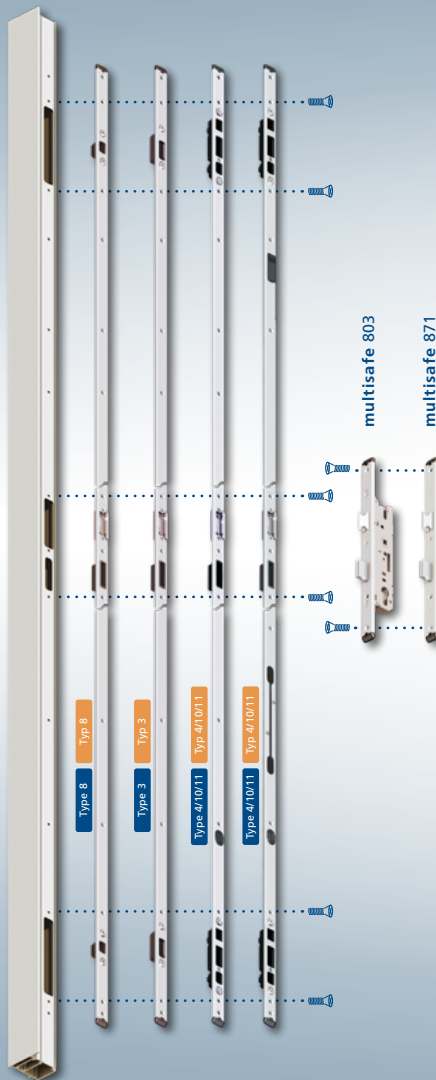



multisafe 855GL

Type 3/8/11

multisafe 859

Typ 3

autosafe 833/833P

Type 4

autotronic 834/834P

Type 4

autosafe 835/835P

Typ 10

autotronic 836/836P

Typ 10

autosafe 837/837P

Typ 10

multisafe 870GL

Typ 11

multitronic 881CL

Typ 11

SYSTEMLÖSUNG SYSTEM SOLUTION

HOLZTÜREN TIMBER DOORS



Rationell
Streamlined



Ansprechend
Sleek



Passgenau
Precise



Effizient
Efficient



Variabel
Variable



Nachhaltig
Sustainable

Prospekt (DE) 

Brochure (EN) 

Website (DE) 

Website (EN) 

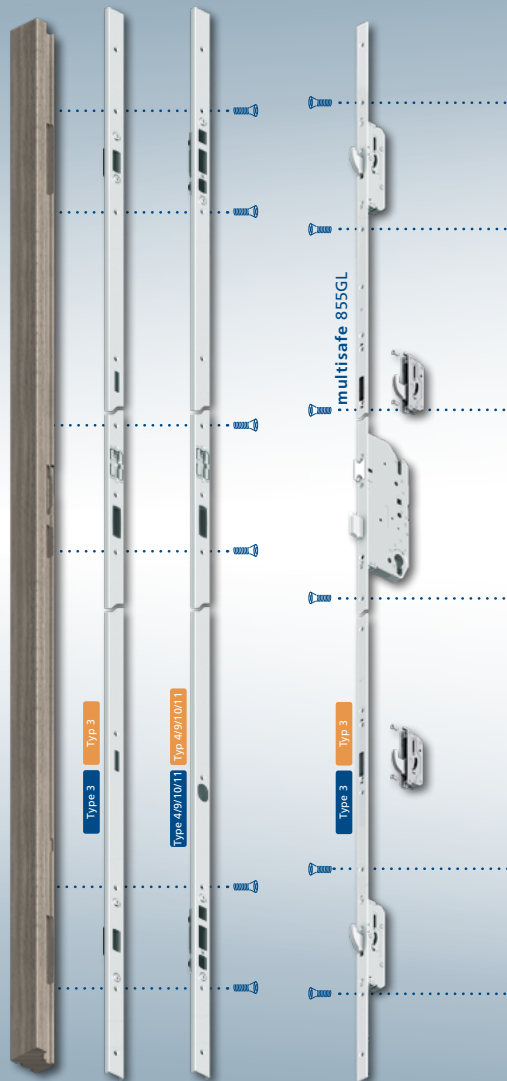

Type 9

Type 9

multisafe 855GL

Type 4

Type 4

autosafe 833/833P

Type 4

Type 4

autotronic 834/834P

Type 10

Type 10

autosafe 835/835P

Type 10

Type 10

autotronic 836/836P

Type 10

Type 10

autosafe 837/837P

Type 11

Type 11

multisafe 855GL

Type 11

Type 11

multisafe 870GL

Type 11

Type 11

multitronic 881GL



SYSTEMLÖSUNG SYSTEM SOLUTION

KUNSTSTOFFTÜREN uPVC DOORS



Rationell
Streamlined



Flexibel
Flexible



Effizient
Efficient



Variabel
Variable



Nachhaltig
Sustainable



Energieeffizient
Energy-efficient

[Prospekt \(DE\)](#)

[Brochure \(EN\)](#)

[Website \(DE\)](#)

[Website \(EN\)](#)



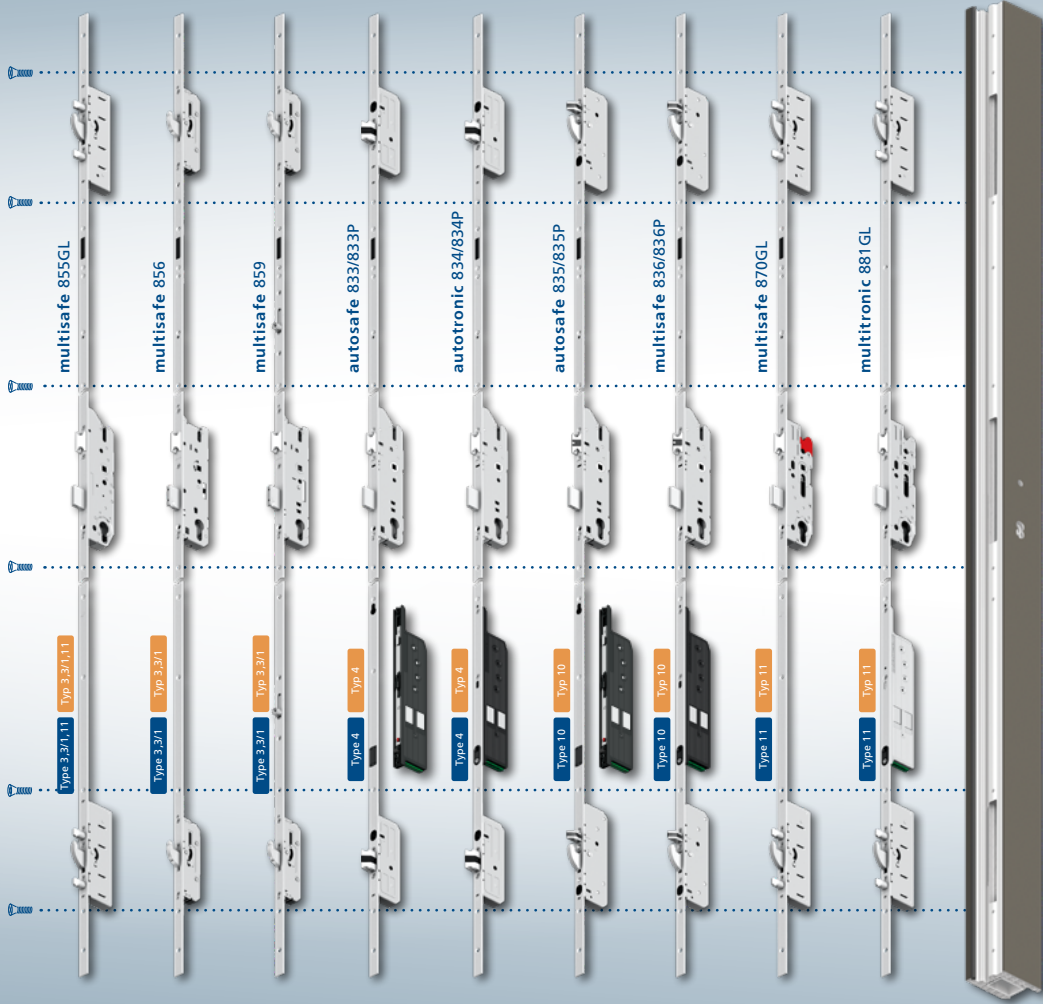

multisafe 855GL

Type 3, 3P, 11

multisafe 856

Type 3, 3P, 1

multisafe 859

Type 3, 3P, 1

autosafe 833/833P

Type 4

autotronic 834/834P

Type 4

autosafe 835/835P

Type 10

multisafe 836/836P

Type 10

multisafe 870GL

Type 11

multitronic 881GL

Type 11

SYSTEMLÖSUNG SYSTEM SOLUTION

KUNSTSTOFFTÜREN/ KOMPAKTPROGRAMM uPVC doors/compact range



Rationell
Streamlined



Vielfältig
Versatile



Flexibel
Flexible



Variabel
Variable



Clever
Clever



Sicher
Secure

Prospekt (DE) 

Brochure (EN) 

Website (DE) 

Website (EN) 



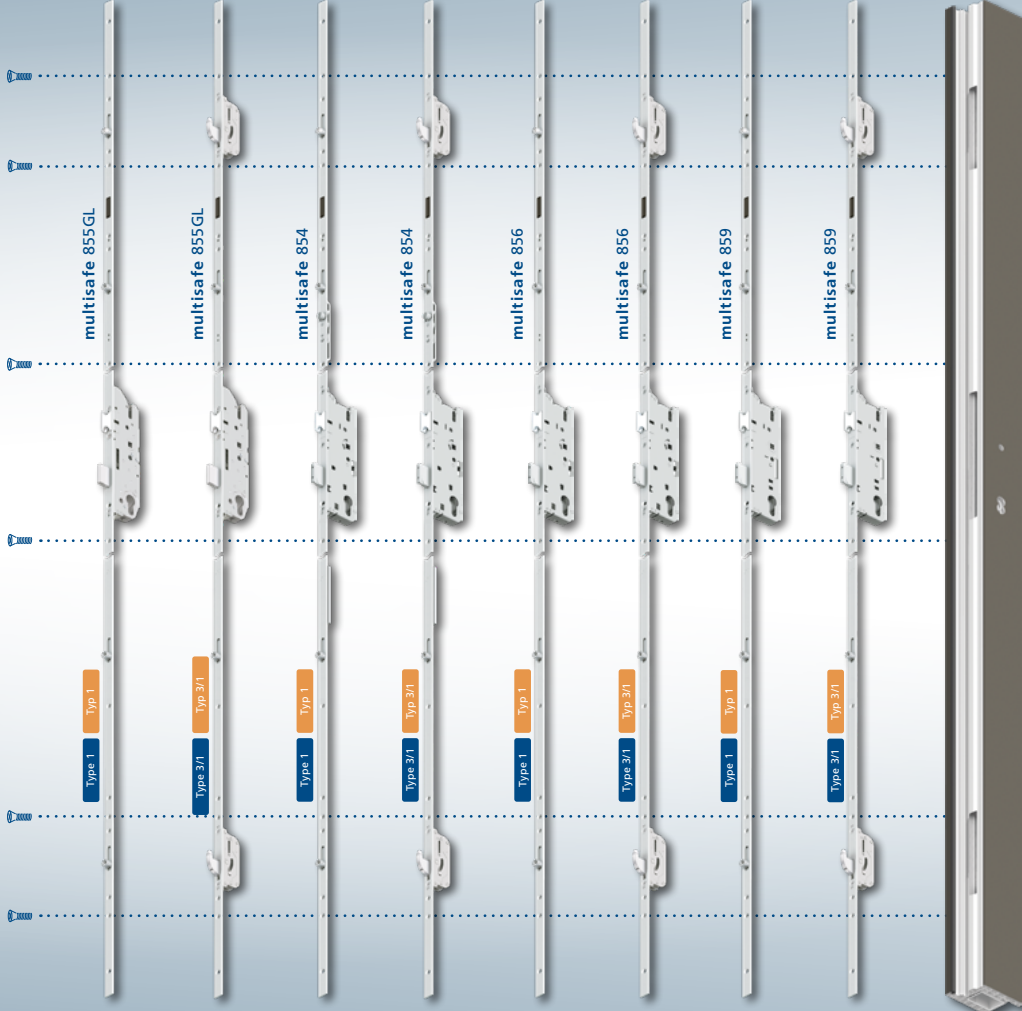

multisafe 855GL

multisafe 855GL

multisafe 854

multisafe 854

multisafe 856

multisafe 856

multisafe 859

multisafe 859

Type 1

Type 1

Type 3/I

Type 3/I

Type 1

Type 1

Type 3/I

Type 3/I

Type 1

Type 1

Type 3/I

Type 3/I

Type 1

Type 1

Type 3/I

Type 3/I



SYSTEMLÖSUNG SYSTEM SOLUTION

FUNKTIONSTÜREN FUNCTIONAL DOORS



Rationell
Streamlined



Flexibel
Flexible



Zertifiziert
Certified



Vielfältig
Versatile





Variabel
Variable



Langlebig
Long-lasting

[Prospekt \(DE\)](#) 

[Website \(DE\)](#) 

[Website \(EN\)](#) 



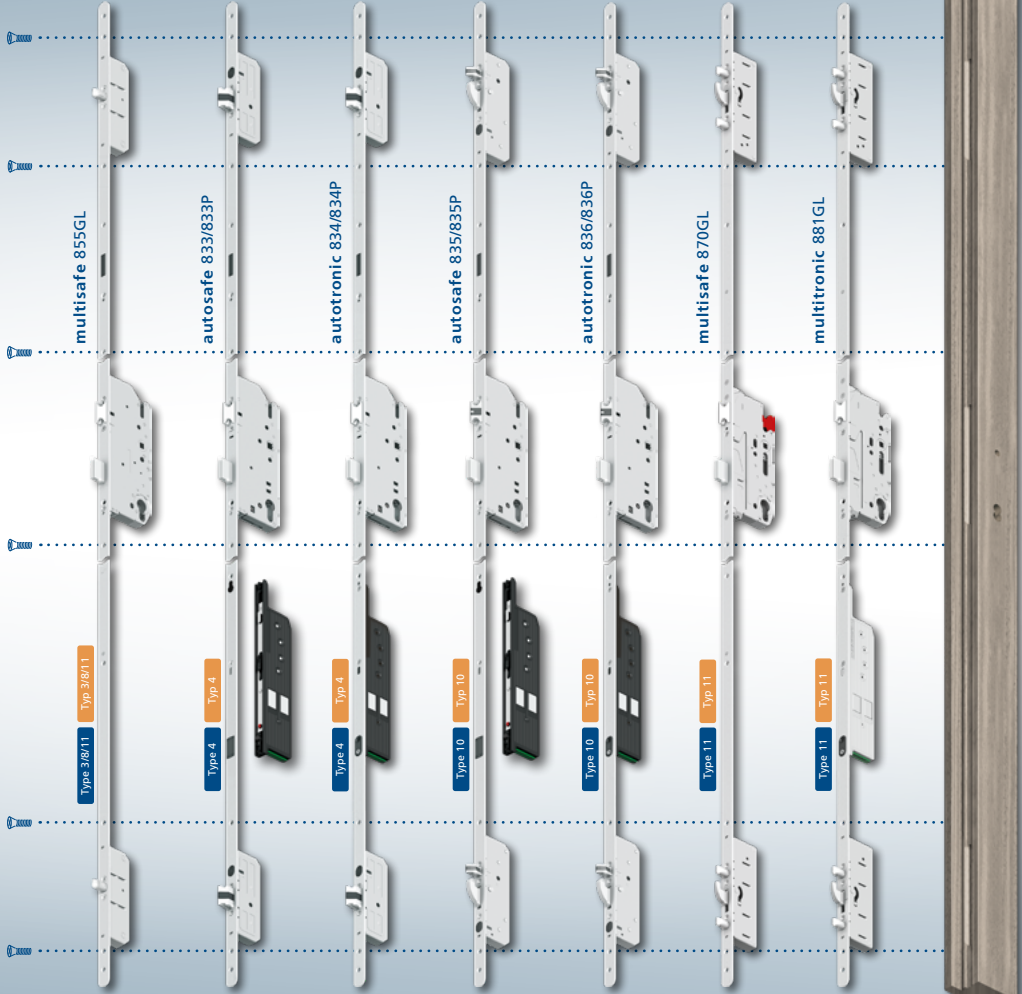

multisafe 855GL

Type 3/8/11 Typ. 8/8/11

autosafe 833/833P

Type 4 Typ. 4

autotronic 834/834P

Type 4 Typ. 4

autosafe 835/835P

Type 10 Typ. 10

autotronic 836/836P

Type 10 Typ. 10

multisafe 870GL

Type 11 Typ. 11

multitronic 881GL

Type 11 Typ. 11



SYSTEMLÖSUNG SYSTEM SOLUTION

WOHNUNGSABSCHLUSSTÜREN APARTMENT ENTRANCE DOORS



Rationell
Streamlined



Ansprechend
Sleek



Passgenau
Precise



Effizient
Efficient



Variabel
Variable



Nachhaltig
Sustainable

Website (DE) 

Website (EN) 



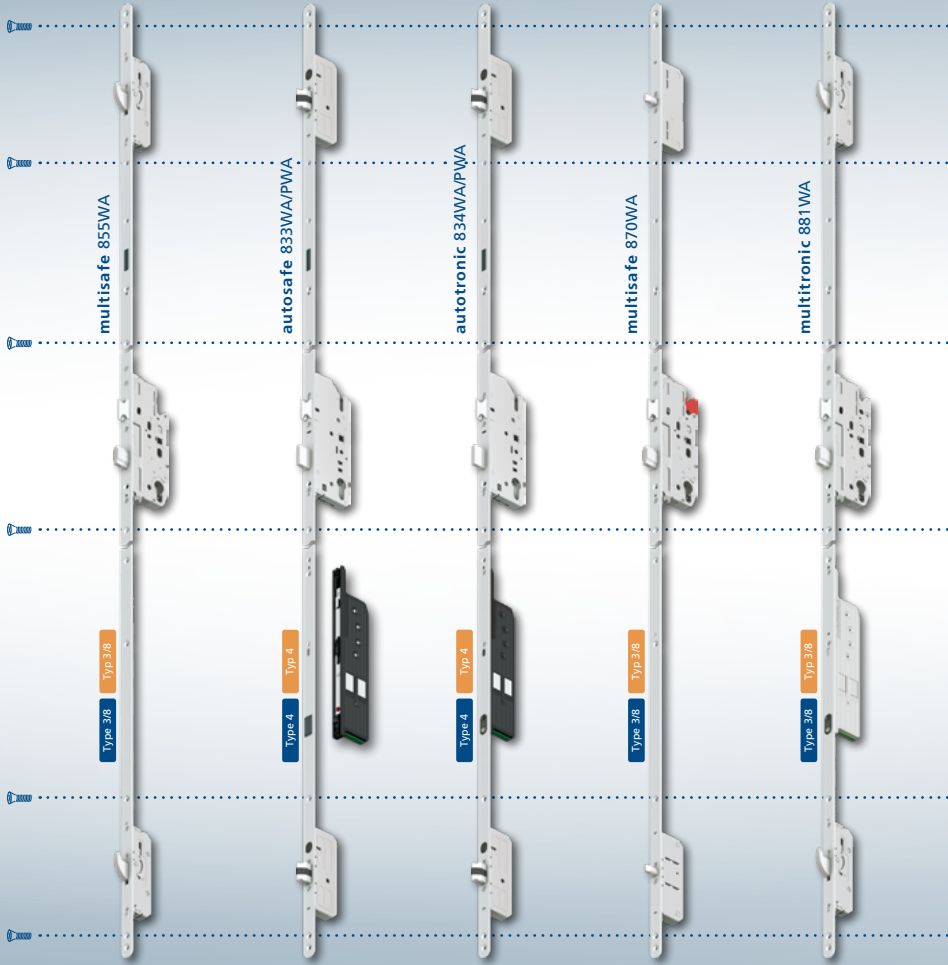

multisafe 855WA

autosafe 833WA/PWA

autotronic 834WA/PWA

multisafe 870WA

multitronic 881WA

Type 3/8

Typ 3/8

Type 4

Typ 4

Type 4

Typ 4

Type 3/8

Typ 3/8

Type 3/8

Typ 3/8



SYSTEMLÖSUNG SYSTEM SOLUTION

ERSATZ UND NACHRÜSTUNG REPLACEMENT & RETROFITTING



Universell
Universal



Sicher
Secure



Flexibel
Flexible



Variabel
Variable



Vielfältig
Versatile



Komfortabel
Convenient

Prospekt (DE) 

Brochure (EN) 

Website (DE) 

Website (EN) 

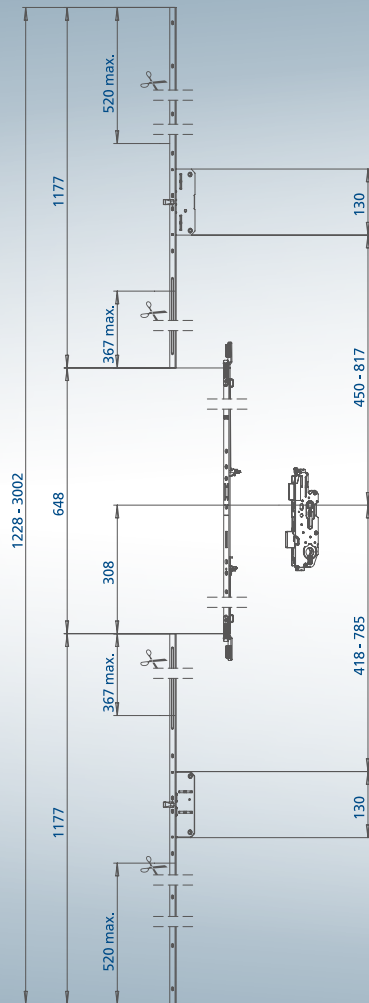

autosafe 833R

Type 4

Typ 4



multisafe 855R

Type 3/6/11

Typ 3/6/11



multisafe 855WER

Type 3/6/11

Typ 3/6/11





Zutrittslösungen und Systemzubehör.
Access solutions and system accessories.

SYSTEM-ERGÄNZUNGEN

SYSTEM ADDITIONS

Mit den FUHR Zutrittslösungen erschließen Sie sich vielfältige Upgrade-Möglichkeiten für Ihre Haustür. Neben der schlüssellosen Öffnung kann auch das Steuern und Überwachen der Tür per Smartphone von jedem Ort aus bequem erledigt werden. Entdecken Sie die grenzenlose Komfort-Vielfalt – ob mit dem Fingerscan oder den intelligenten Lösungen für die SmartHome-Anwendung. Darüber hinaus unterstützt ausgewähltes Systemzubehör, wie z.B. Elektro-Türöffner oder Verlängerungen, immer die bedarfsgerechte Ausstattung jeder Tür.

FUHR access solutions provide a wide range of upgrade options for your front door. Aside from opening your door keylessly, you can also control and monitor it conveniently from any location using your smartphone. Discover convenience in limitless variety – from fingerprint scanners to intelligent solutions for smart home applications. In addition, selected system accessories, such as electric strikes or extensions, ensure that every door is always equipped with the features it needs.

SYSTEM-ERGÄNZUNGEN

SYSTEM ADDITIONS

ZUTRITTSLÖSUNGEN

ACCESS SOLUTIONS

Website (DE) ▶

Website (EN) ▶



▶ SmartConnect door

Kompakte Video-Türsprechanlage zur Bedienung per App, einfache Montage ohne aufwändige Verkabelung.

Compact video door intercom for operation via app, easy installation without cumbersome wiring.



▶ SmartConnect easy

Bequeme Türöffnung und SmartHome-Überwachung per Smartphone – sicher dank WLAN.

Easy door opening and SmartHome monitoring via smartphone – secure thanks WiFi.



▶ SmartTouch 2.0

Schlüssellose Komfortöffnung per "KeylessGo".

Convenient keyless opening with "KeylessGo".

SYSTEM-ERGÄNZUNGEN

SYSTEM ADDITIONS

ZUTRITTLÖSUNGEN

ACCESS SOLUTIONS

[Website \(DE\)](#)

[Website \(EN\)](#)

▶ **Fingerscan multiscan go** multiscan go fingerprint scanner

Schlüssellose, biometrische Zutrittskontrolle mit Master-Funkschlüssel zur Programmierung, kein Masterfinger erforderlich. Auf unserer Website finden Sie weitere Zutrittslösungen, wie z. B. Funkschlüssel, Transponder oder Funktastatur.

Keyless biometric access control with master radio key for programming. No master finger required. Visit our website for other access solutions, including radio keys, transponders and radio keypads.

FUHR



SYSTEM-ERGÄNZUNGEN

SYSTEM ADDITIONS

ELEKTRO-TÜRÖFFNER

ELECTRIC STRIKES

Website (DE) 

Website (EN) 

Türöffner-Serie e-motion e-motion door strike series

Symmetrisch, mit Radiusfalle und einzigartigem Fallenteil, rechts/links einsetzbar, optional stehen profilspezifische Fallenschieber zur Verfügung.

Symmetrical, with radius latch and unique latch component, non-handed use, optional profile specific latch slides are available.

FUHR



SYSTEM-ERGÄNZUNGEN

SYSTEM ADDITIONS

ZUBEHÖR

ACCESSORIES

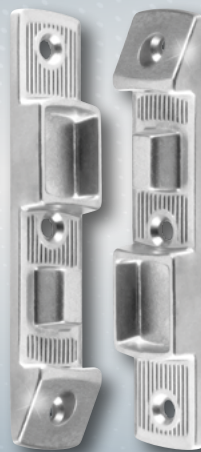

▶ **Bandseiten-Sicherungen**
Dog bolts

Website (DE) ▶

Website (EN) ▶

FUHR



▶ **Verlängerungen**
Extensions



▶ **Magnete**
Magnets



▶ **Riegelschaltkontakte**
Deadbolt switching contacts



Sicherheit über die Tür hinaus.
Security beyond the door.

PROGRAMM-ERGÄNZUNGEN

PRODUCT RANGE ADDITIONS

Entdecken Sie unser breites Angebot an stabilen Verschlüssen für den Standflügel zweiflügeliger Türen und Tore aus Metall, Kunststoff und Holz mit abgestimmten Kant- und Treibriegeln. Auch für die verlässliche Absicherung von Industrietoren sowie falt- und Schiebetoren steht ein breites Programm zur Verfügung, selbstverständlich mit umfangreichem Zubehör.

Für die nachträgliche Sicherung von Fenstern steht eine überzeugende Lösung bereit, die hohe Stabilität durch soliden Stahl garantiert. Die Montage der Fenstersicherung ist völlig unkompliziert und schnell durchzuführen.

Discover our wide range of sturdy locks for the inactive leaf of double-leaf doors and gates made of metal, uPVC and timber with matching espagnolette bolts and drive locks. We also have a large assortment of products for reliably securing industrial doors as well as folding and sliding doors, along with an extensive variety of accessories.

We offer a compelling solution for retrofitting windows with solid steel for excellent strength. Installation of the window locking device is quick and painless.

PROGRAMM-ERGÄNZUNGEN

PRODUCT RANGE ADDITIONS

FENSTERSICHERUNG

WINDOW LOCKING DEVICE

[Website \(DE\)](#)



[Website \(EN\)](#)



METALLBAU & RIEGEL

METAL CONSTRUCTION & BOLTS

[Website \(DE\)](#)



[Website \(EN\)](#)



▶ **Fenstersicherung**
Window locking device

The logo for FUHR, consisting of the letters 'FUHR' in white, bold, sans-serif font, centered within a dark blue rounded rectangular background.A small orange arrow pointing to the right, positioned to the left of the text.

Metallbau & Riegel
Metal construction & bolts

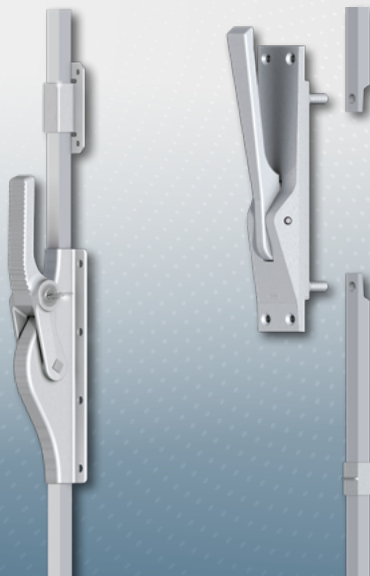

VORSCHAU: PRODUKTE. SYSTEME. LÖSUNGEN.

PREVIEW: PRODUCTS.SYSTEMS.SOLUTIONS.

Hier finden Sie Informationen zu Neuheiten und aktuellen Produktentwicklungen, die wir bei unseren Messeauftritten präsentieren. Wir arbeiten kontinuierlich an Ideen, die Sie weiterbringen. Bleiben Sie gespannt auf das, was kommt.

Here is information on new products and current product innovations that we present at trade fairs. We are constantly working on ideas that will take you further. Stay tuned for what's coming next.

VORSCHAU
PREVIEW



Sämtliche Bild-, Produkt-, Maß- und Ausführungsangaben entsprechen dem Tag der Drucklegung. Änderungen, die dem technischen Fortschritt und der Weiterentwicklung dienen, behalten wir uns vor. Modell- und Produktsprüche können nicht geltend gemacht werden. Für Druckfehler wird keine Haftung übernommen.

All images and details of products, dimensions and designs were accurate at the time of going to press. We reserve the right to make changes in the interest of technical progress. Claims relating to specific models or products cannot be asserted. We accept no liability for misprints.

FUHR

CARL FUHR GmbH & Co. KG
Schlösser und Beschläge

Carl-Fuhr-Straße 12
D-42579 Heiligenhaus
Tel.: +49 2056 592-0
www.fuhr.de · info@fuhr.de